

Analog HD IR  
INTELLIGENT SPEED DOME CAMERA  
**USER INSTRUCTION**  
USE/INSTALLATION

### **Special Declaration**

Before connecting and using this device, please read this manual carefully and properly preserved for reference in the future.

This manual may contain some inaccurate place in technology, or some printing error. The contents of this manual will update from time to time, but without notice if there is any upgrades; Update contents will be added in new version manual. We will improve or update the product or program of this manual at any time.

## **CAUTION**

### **Careful Transport**

During transport, custody and install process should prevent weight, severe vibration and soak damage to product.

### **Do Not Disassemble Zoom Camera**

In order to well match night vision, we sell IR speed dome camera with zoom camera, please not disassemble zoom camera if there is no technical person.

### **Power Supply, Video Cable and Control Cable**

For power supply cable, video cable and control cable, please adopt shielded cable and independent wiring, can not mix with other cables.

### **Electric Safety**

Should obey all kinds of electric standard when using speed dome camera, make sure signal cable keep enough distance(at least 50m)with high voltage equipment or cables. If it is possible, please take lightning and surge measurement.

### **Clean**

When clean camera housing, please use dry soft cloth to wipe, If it is too dirty, please use neutral cleaner to wipe lightly. Do not use strong or grind cleaner to prevent its housing from scratching.

### **Strictly Sealed**

Prevent liquid or other things get into speed dome housing, else it will cause permanent damage.

### **Please do not use camera beyond limited temperature and humidity**

Speed dome camera working temperature : -25°C to 50°C, humidity less than 90%.

### **Please do not install camera near air conditioner's outlet**

Under following situation, lens will be fogged because of condensation:

- \*Use under the environment where the temperature rise and down frequently which caused by the air conditioner power on and off frequently.
- \*Use in environment which can make glass fog.
- \*Use in environment full with smoke or dust.

### **Please do not make camera toward to strong light source, such as the sun**

Toward camera to strong light source for a long time will damage the color filter on CCD or CMOS, then it will make image lose color.

<b>Chapter 1 Product Overview</b> .....	3
1.1 Product features .....	3
1.2 Speed dome Parameter.....	3
1.3 Structure Dimension.....	4
<b>Chapter 2 Installation</b> .....	8
2.1 Install Instruction.....	8
2.2 Install Method.....	8
2.3 Baud rate Setup .....	17
2.4 Address Setup.....	17
2.5 Power supply and Control cable Connection .....	18
2.6 Connecting Method.....	18
2.7 Cable Mark Instruction .....	19
2.8 Typical wiring diagram.....	19
<b>Chapter 3 Basic Operation</b> .....	20
3.1 Self-test when power on .....	20
3.2 Preset setup.....	20
3.3 Call preset .....	20
3.4 Function Realization By Preset .....	21
3.5 Patrol Setting.....	25
<b>Chapter 4 Appendix</b> .....	26
4.1 FAQs.....	26
4.2 Clean the transparent cover .....	26
4.3 Lightning and Surge protection .....	27
4.4 RS485 bus wiring .....	28

## Chapter 1 Product Overview

### 1.1 Product Feature

#### Strong Intelligent Function

- PELCO-D/P,Hikvision,Dahua and other control protocol auto diagnosis.
- 2400.4800,9600 baud rate auto diagnosis.

#### PTZ Control

- Using RS485 Protocol, Video Transmission Distance 500m in theory.
- Pan 0-360 degree continue rotate, tilt 0-90 degree, no monitor blind spot.
- Support CCVC, Control Speed Dome Camera Speed. The Zoom will auto adjust according the lens zoom

#### Night vision function

- Turn on the ir light according to the backlight strength.
- adjust the ir light's brightness level according to the zoom times.

### 1.2 Speed dome camera parameter

Electric			
Rated Voltage	DC12V 4A ± 10%	Power Consumption	10 Max at daytime, 30Max at night(without heating)
Decoder	Built in	IR distance	100-120m
Set			
Communication protocol	PELCO-D/P HIK/DAHUA	ID	1-255
Baud rate(RS485)	2400/4800/9600bps/auto identify		
Operate			
Pan rotate	360 endless	Tilt rotate	90 degree
Speed	Middle Speed:Pan 6~30 °/S Tilt 4~17 °/S	Preset	220
	High Speed:Pan 0.1~200 °/S Tilt 4~30 °/S	Monitor mode Preset.	patrol,pan scan and pattern scan
Environment			
Operate environment	Outdoor: -20°C~60°C Indoor: -10°C~50°C	environment humidity	0-95% without condensation
Weather-proof level	IP66		
Physical			
Installation mode	Wall mount/ceiling mount		

## 1.3 Structure Dimension

### H type speed dome Dimension

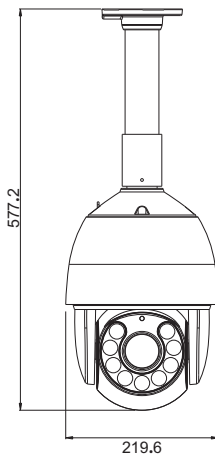
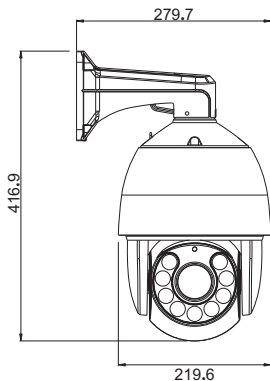

unit:mm

### H tape bracket Dimension

#### Wall mount bracket

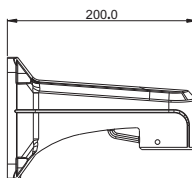
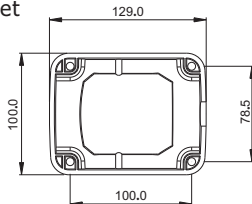

### Ceiling mount bracket

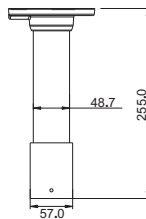
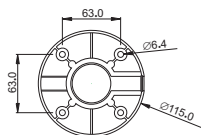

unit:mm

unit:mm

## Chapter 1 Product Overview

### R type speed dome Dimension

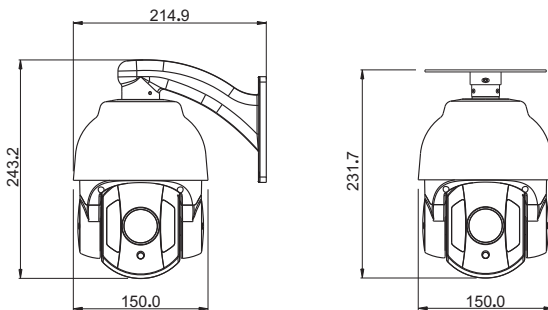

### R type bracket Dimension

#### Wall mount bracket

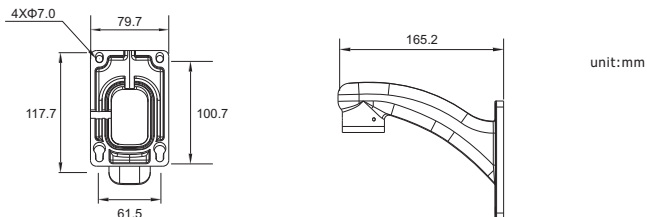

#### Ceiling mount bracket

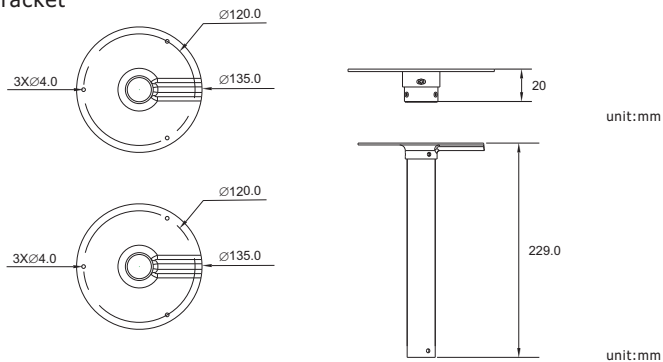

## N type speed dome Dimension

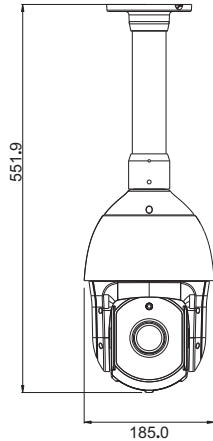
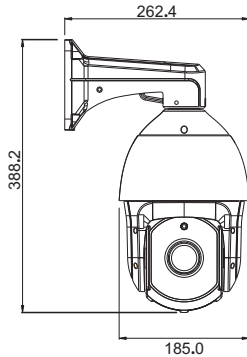

unit:mm

## N type bracket Dimension Wall mount bracket

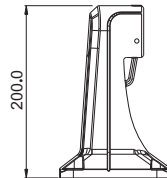
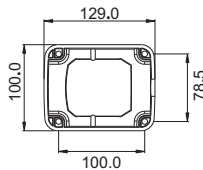

## Ceiling mount bracket

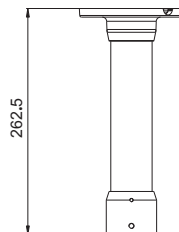
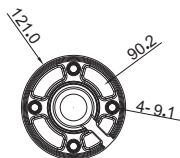

unit:mm



# Chapter 1 Product Overview

Dimension

## U type speed dome Dimension

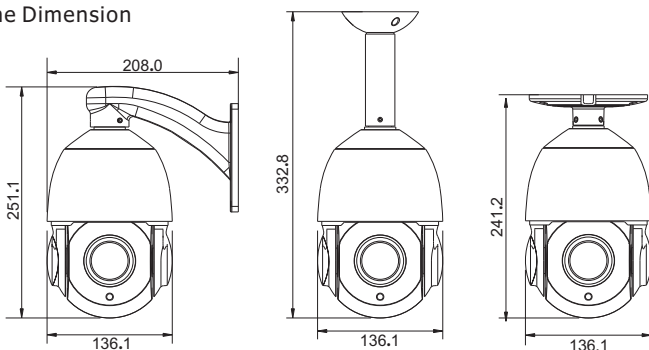

unit:mm

## U type bracket Dimension

### Wall mount bracket

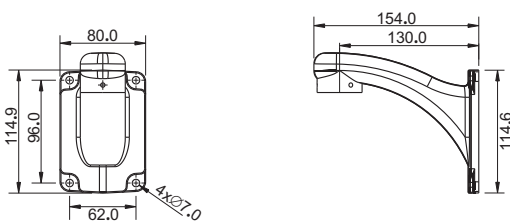

### Ceiling mount bracket

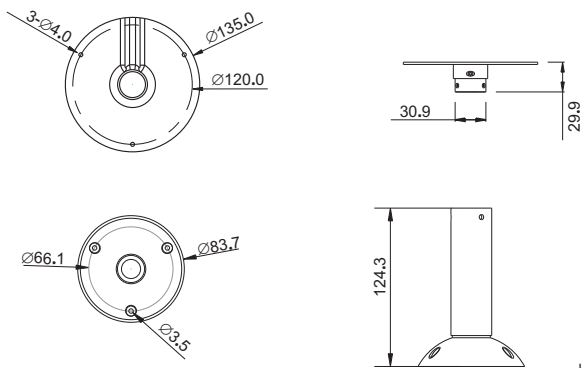

unit:mm

### 2.1 Install Instruction

Prepare before installation

In order to prevent troubles, installation should be done by professional staff base on corresponding rules.

Confirm all spare-parts are complete, ensure application of this speed dome camera and installation mode is suitable for requirement.

Wall/ceiling mount speed dome composite with bracket, zoom camera, transparent cover and other parts.

### 2.2 Installation Method

#### H type speed dome camera installation method

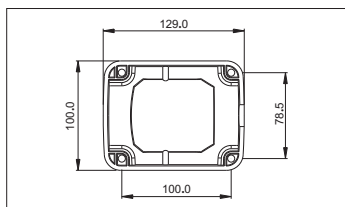

Wall mount bracket

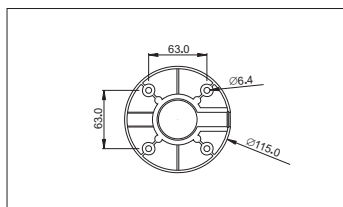

Ceiling mount bracket

#### Step 1-Draw positioning holes

Take out bracket from package box, mark the holes' position based on wall mount bracket bottom 4pcs installation holes.

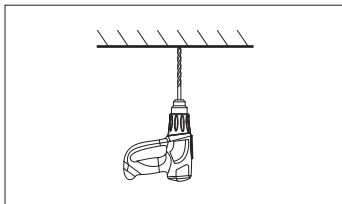
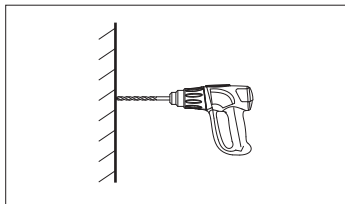

#### Step 2-Drill holes and put expansion screws in

Drill 4pcs expansion screw's installation holes at pre-marked position, then put 4pcs expansion screws in. (Note: please bring expansion screws own.)

## Chapter 2 Installation

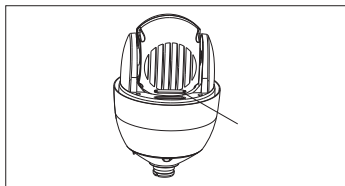

Step 3-Unscrew 2pcs screws which used to fix the transparent cover for DIP switch

Use screwdriver open 2pcs screw which used to fix transparent cover for DIP switch, then move transparent cover from speed dome camera.

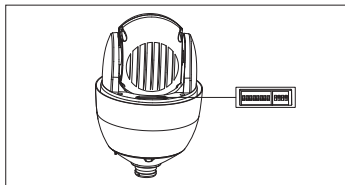

Step 4-Set DIP switch

Please refer to section three of this chapter-Baud rate setup

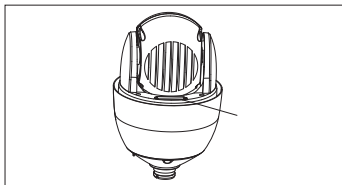

Step 5-install transparent cover of DIP switch

After finishing baud rate setup, install transparent cover of DIP switch again.

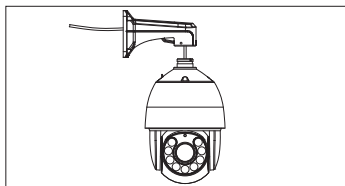

Step 6-Lead cable through bracket. Lead the cable through bracket hole.

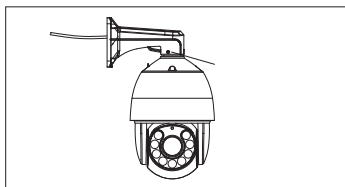
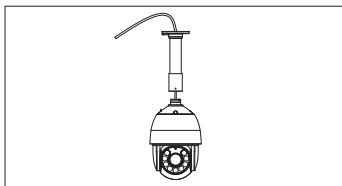

Step 7-Connect speed dome and bracket

Put speed dome camera connection port into bracket hole, screw 4pcs hexagon screws into corresponding screw holes.

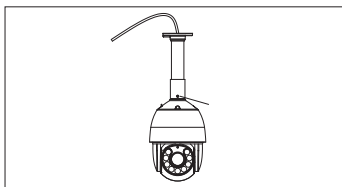

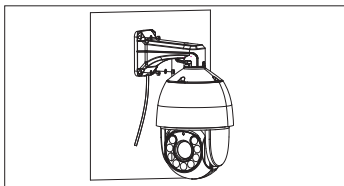

Step 8-Fix speed dome camera.

In order to get good waterproof effect, first install rubber seals on bracket, and lead the cable out from the wiring port, then fix it on the wall/ceiling by using 4 screws. Seal the wiring port of the bracket by using silicon sealant.

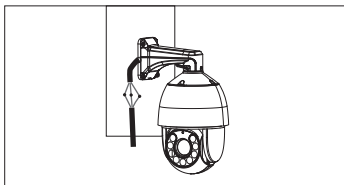
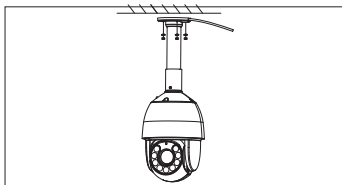

Step 9-Cable Connection

Please refer to section six of this chapter-Connection method.

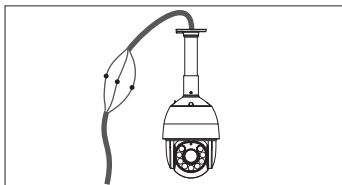

### R type speed dome camera installation method

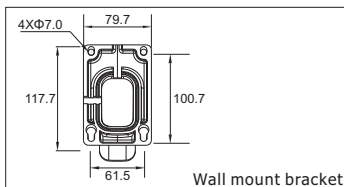

Step 1-Draw positioning holes

Take out bracket from package box, mark the holes' position based on wall mount bracket bottom 4pcs installation holes.

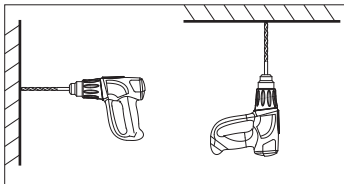
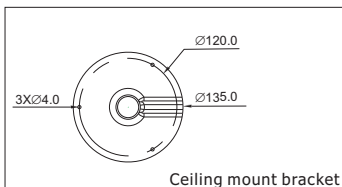

Step 2-Drill holes and put expansion screws in

Drill 4pcs expansion screw's installation holes at pre-marked position, then put 4pcs expansion screws in. (Note: please bring expansion screws own.)

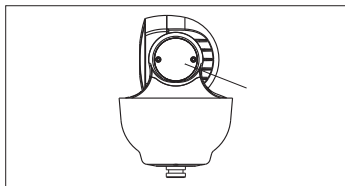

Step 3- Unscrew 2 pcs screws which used to fix the transparent cover for DIP switch

Use screwdriver open 2 pcs screw which used to fix transparent cover for DIP switch, then move transparent cover from speed dome camera.

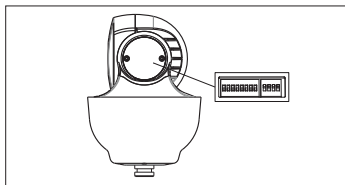

Step 4- Set DIP switch.

Please refer to section 3 of this chapter-Baud rate setup.

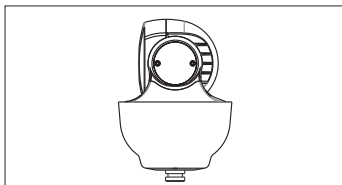

Step 5- install transparent cover of DIP switch.

After finishing baud rate setup, install transparent cover of DIP switch again.

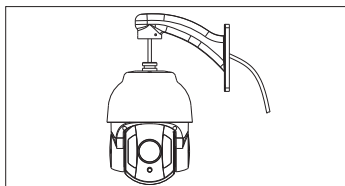

Step 6- Lead cable through wall mount bracket.

Lead the cable through wall mount bracket hole.

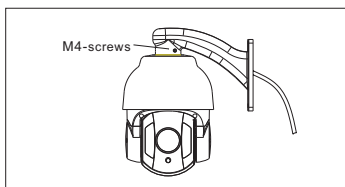
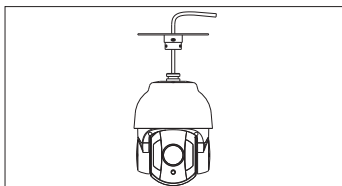

Step 7- Connect speed dome and wall mount bracket.

Put speed dome camera connection port into bracket hole, screw 4 pcs hexagon screws into corresponding screw holes.

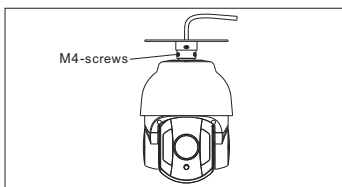

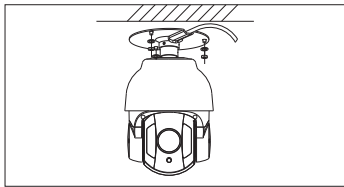
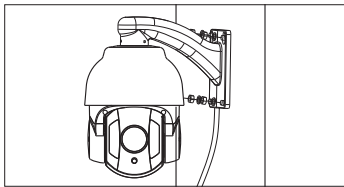

**Step 8-Fix speed dome camera on wall.**

In order to get good waterproof effect, first install rubber seals on wall mount bracket, and lead the cable out from the wiring port, then fix it on the wall by using 4 screws. Seal the wiring port of the bracket by using silicon sealant.

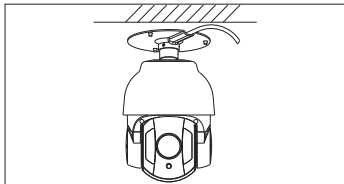
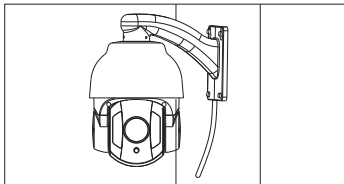

**Step 9-Cable Connection**

Please refer to section six of this chapter-Connection method.

**Step 10-Tear off protection film**

Teal off protection film of transparent cover

Note: please take care of transparent cover.

### N type speed dome camera installation method

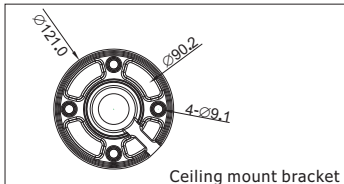
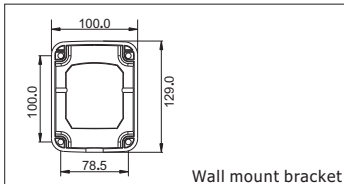

**Step 1-Draw positioning holes**

Take out bracket from package box, mark the holes' position based on wall mount bracket bottom 4pcs installation holes.

## Chapter 2 Installation

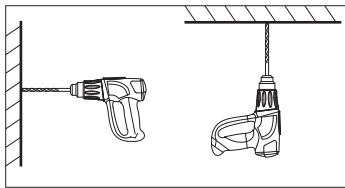

Step 2-Drill holes and put expansion screws in

Drill 4pcs expansion screw's installation holes at pre-marked position, then put 4pcs expansion screws in. (Note: please bring expansion screws own.)

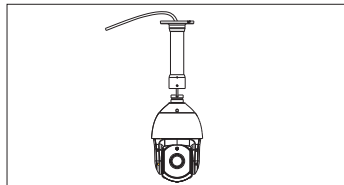
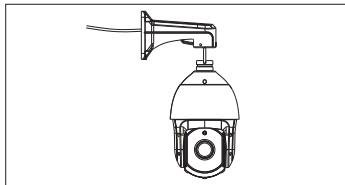

Step 3-Lead cable through wall mount bracket.

Lead the cable through wall mount bracket hole.

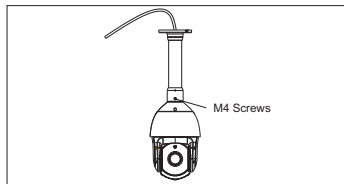
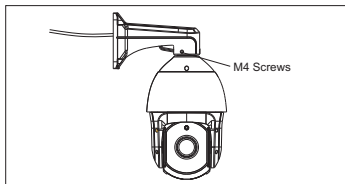

Step 4-Connect speed dome and wall mount bracket.

Put speed dome camera connection port into bracket hole, screw 4pcs hexagon screws into corresponding screw holes.

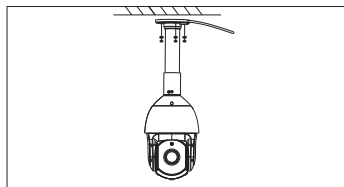
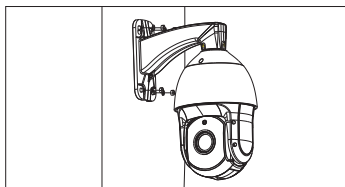

Step 5-Fix speed dome camera on wall.

In order to get good waterproof effect, first install rubber seals on wall mount bracket, and lead the cable out from the wiring port, then fix it on the wall by using 4 screws. Seal the wiring port of the bracket by using silicon sealant.

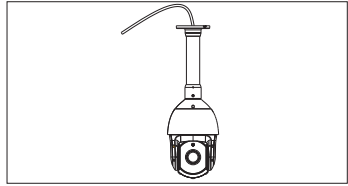
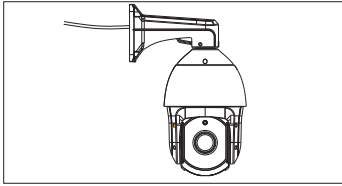

### Step 6-Cable Connection

Please refer to section six of this chapter-Connection method.

### Step 7-Tear off protection film

Teal off protection film of transparent cover

Note: please take care of transparent cover.

## U type speed dome camera installation method

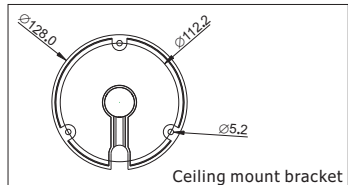
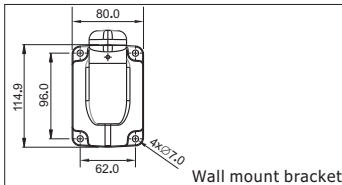

### Step 1-Draw positioning holes

Take out bracket from package box, mark the holes' position based on wall mount bracket bottom 4pcs installation holes.

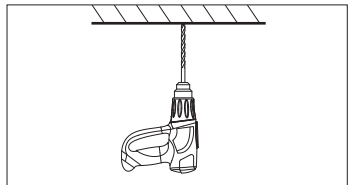
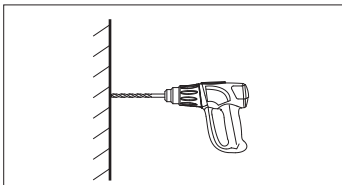

### Step 2-Drill holes and put expansion screws in

Drill 4pcs expansion screw's installation holes at pre-marked position, then put 4pcs expansion screws in.

(Note: please bring expansion screws own.)



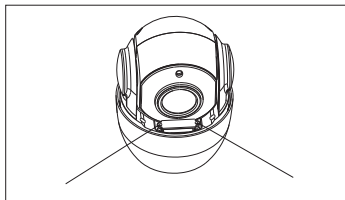

**Step 3- Unscrew 2pcs screws which used to fixed the transparent cover for DIP switch**

Use screwdriver open 2pcs screw which used to fix transparent cover for DIP switch, then move transparent cover from speed dome camera.

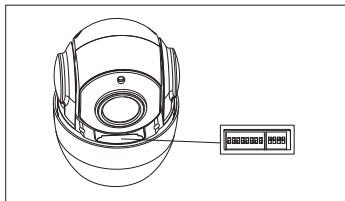

**Step 4- Set DIP switch.**

Please refer to section 3 of this chapter-Baud rate setup.

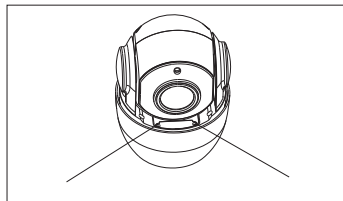

**Step 5- install transparent cover of DIP switch.**

After finishing baud rate setup, install transparent cover of DIP switch again.

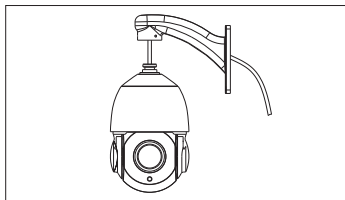

**Step 6- Lead cable through wall mount bracket.**

Lead the cable through wall mount bracket hole.

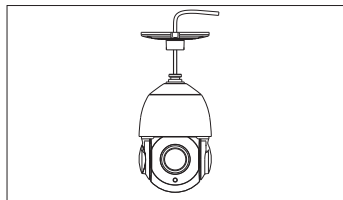

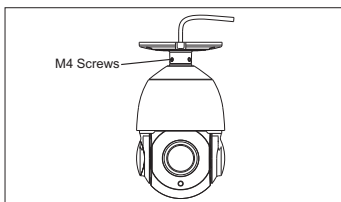
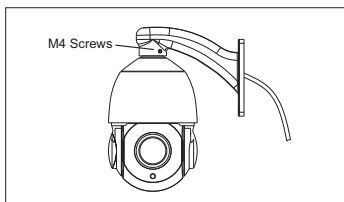

### Step 7-Connect speed dome and wall mount bracket.

Put speed dome camera connection port into bracket hole, screw 4pcs hexagon screws into corresponding screw holes.

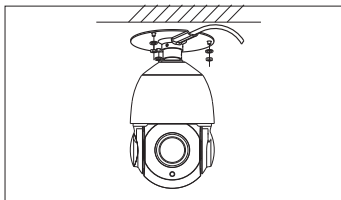
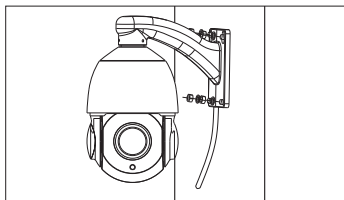

### Step 8-Fix speed dome camera on wall.

In order to get good waterproof effect, first install rubber seals on wall mount bracket, and lead the cable out from the wiring port, then fix it on the wall by using 4 screws. Seal the wiring port of the bracket by using silicon sealant.

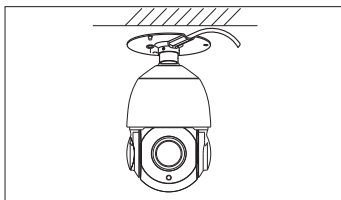
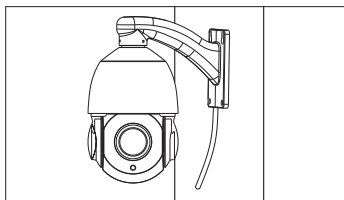

### Step 9-Cable Connection

Please refer to section six of this chapter-Connection method.

### Step 10-Tear off protection film

Tear off protection film of transparent cover

Note: please take care of transparent cover.

## Chapter 2 Installation

### 2.3 Baud Rate Setup

Baud rate and corresponding DIP status as below:

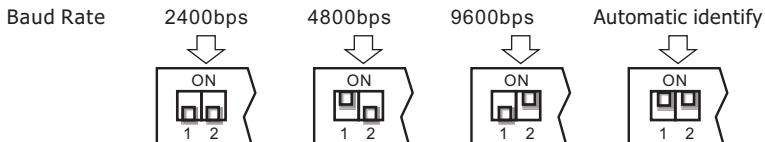

Rs485 control bus need all device which connect to it shall be in parallel mode, and each end of the system shall be connected to a 120ohm resistor. Our speed dome has a 120ohm resistor in it, you need only set it up through dip switch SW2, put the 4th switch on, then the resistor is connected, details as below:

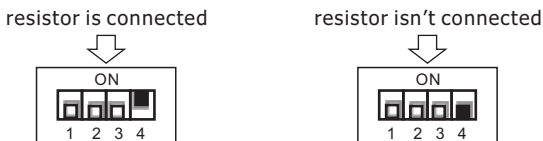

### 2.4 ID Setup

ID setup (address code setup obey binary rules)  
address code shall be set through 8 DIP switch (SW1).  
Keyboard control speed dome through communication bus, one keyboard can control max. 255pcs speed dome camera, each speed dome camera has its own address code, user can set address code through 8 DIP switch, details as bellow:



Address	SW1 Switch Setup							
	SW1-1	SW1-2	SW1-3	SW1-4	SW1-5	SW1-6	SW1-7	SW1-8
1	ON	OFF	OFF	OFF	OFF	OFF	OFF	OFF
2	OFF	ON	OFF	OFF	OFF	OFF	OFF	OFF
3	ON	ON	OFF	OFF	OFF	OFF	OFF	OFF

4	OFF	OFF	ON	OFF	OFF	OFF	OFF	OFF
5	ON	OFF	ON	OFF	OFF	OFF	OFF	OFF
6	OFF	ON	ON	OFF	OFF	OFF	OFF	OFF
7	ON	ON	ON	OFF	OFF	OFF	OFF	OFF
8	OFF	OFF	OFF	ON	OFF	OFF	OFF	OFF
9	ON	OFF	OFF	ON	OFF	OFF	OFF	OFF
10	OFF	ON	OFF	ON	OFF	OFF	OFF	OFF
11	ON	ON	OFF	ON	OFF	OFF	OFF	OFF
12	OFF	OFF	ON	ON	OFF	OFF	OFF	OFF
---	---	---	---	---	---	---	---	---
254	OFF	ON	ON	ON	ON	ON	ON	ON
255	ON	ON	ON	ON	ON	ON	ON	ON

Note: Due to the N dome camera not dial the code switch, N address by enabling software to set up.

### 2.5 Power supply and control cable connection

Power supply connection

Note: Please check rated voltage and power supply carefully, rated voltage and current as bellow:

rated voltage	rated voltage range	current
H/N:DC12V ( AC 24V Optional)	± 10%	4A
R/U:DC12V	± 10%	2A

Control line connection

Connect RS485 line to keyboard controller or DVR, if there are more than one need to be controlled by keyboard or DVR, please connect it in parallel.

Note: (1) protocol and baud rate of keyboard and DVR can be set by customer, just make sure it is same with that of speed dome.

(2) the ID of different speed dome which is in same system shall be set as different.

(3) It should set the difference PTZ Camera Address in Monitor system with multi cameras.

### 2.6 Connection Method

Connection method as bellow diagram, connect video cable, control cable, power supply cable in turn. Connection method of keyboard can refer to keyboard manual (connection cable order based on keyboard model, here only provide one possible example), please refer to bellow diagram for detail.

## Chapter 2 Installation

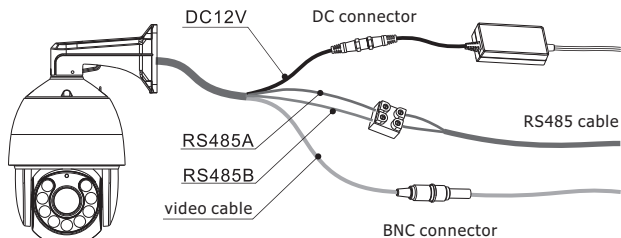

### 2.7 Cabling Mark Instruction

Port Mark	Port Instruction	Cable Color	Connection Instruction
Power supply cable	DC12V input power	DC connector	Connect DC12V input power
RS485A	485 Communication bus A	White	Connect bus cable A(here in example connect PTZ-CON Ta)
RS485B	485 Communication bus B	Green	Connect bus cable B(here in example connect PTZ-CON Tb)
Video cable	Video cable	BNC port	Connect Monitor or Analog HD DVR

### 2.8 Typical Application wiring Diagram

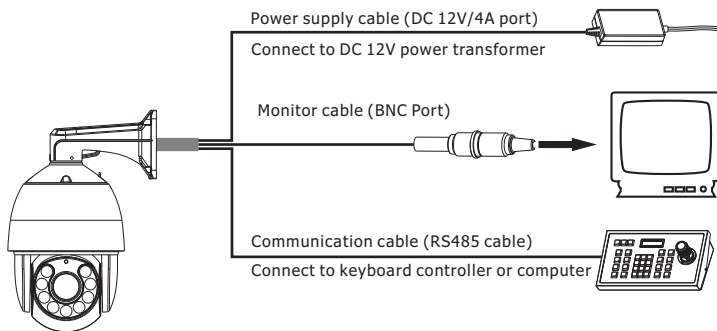

Because different system platform's specific operation method is not totally same, generally subject to manufacturer's manual, different situation has special requirements and operation method. Please contact distributor to obtain necessary information. Hereby only introduce control method when it connect universal keyboard controller.

### 3.1 Power-on Self-test

After power-on speed dome camera, it will action in pan and tilt direction automatically. Through self-test to confirm speed dome camera working normally.

Control speed dome camera up, down, left and right rotate:

After select one camera, can manual control speed dome camera's up, down, left and right movements through keyboard joystick. Rocking of joystick control camera action, when joystick rock to right, camera will also move to right, similarity, when joystick move to left then camera will also move to left. When joystick move in tilt direction, camera also will make corresponding action in tilt direction. When rock joystick in diagonal direction, can make camera make pan and tilt direction action at the same time, and the movement direction same as joystick.

### 3.2 Preset Setting

Operation steps as below:

- (1) Select camera (please refer to keyboard controller manual for details)
- (2) Operate joystick or zoom +/- button to adjust camera image;
- (3) Press (PRESET) + (N) (input specified preset number) + (ENTER), save current position parameters as a preset.

### 3.3 Call a Preset

Operation steps as below:

- (1) Select camera;
- (2) Press (SHOT) + (N) (input specified preset number) + (ENTER), camera move to corresponding preset position at once, zoom +/- will also adjust according to the parameter of preset automatically.

### 3.4 Function Realization By Preset

Adopting the method of double-layer presets, achieve all the functions of the camera by preset call, Specific correspond <<Preset Function Table of General Function>> and <<Preset Function of Specific Function>>.

Call mode: call mode is on in general preset of call, specific function is achieved by the mode of preset call; for example: [92] + [SHOT] + [1] + [SHOT], which is to call patrol 1;

Setting mode: setting mode is on in general preset of setting, specific function is achieved by the mode of preset call; for example: [92] + [PRESET] + [1] + [SHOT], which is to set patrol 1.

#### Preset Function Table of General Function

General Function	Preset	Remarks
IR	90	
Zoom module	91	
Patrol scan	92	
Pattern scan	93	
PTZ control	94	
Menu	95	Support dome menu
System Setting	96	
Reservation	97	
High speed auto scan	98	
Low speed auto scan	99	

## Preset Function Of Specific Function

General Function	Preset No.	Call Mode	Setting Mode	Remarks
IR Function only support IR speed dome camera	1	Auto ON/OFF		
	2	Forced ON		
	3	Force OFF		
	11	High Sensitivity		
	12	Middle Sensitivity		
	13	Low Sensitivity		
Zoom Module Setting	1	IRCUT - ON		
	2	IRCUT - OFF		
	3	IRCUT - AUTO ON		
	4	IRCUT - AUTO OFF		
	50	Zoom Camera Automatic Diagnosis		
	51	SONY		
	52	HITACHI		
	53	SAMSUNG		
	54	HIK		
	55	MYTECH		
	56	LG		
	57	LG-XDI		
	58	CNB		
59	CNB 36 x Optical Zoom			



## Chapter 3 Basic Operation

Zoom Module Setting	60	GV		
	61	SWELL		
	62	BQL		
	63	WIT		
	80	Enter module menu		Module support OSD function
	81	Confirm function in OSD menu		
Patrol Scan	1	Call patrol 1	Patrol 1 setting start	
	2	Call patrol 2	Patrol 2 setting start	
	3	Call patrol 3	Patrol 3 setting start	
	4	Call patrol 4	Patrol 4 setting start	
	5	Call patrol 5	Patrol 5 setting start	
	6	Call patrol 6	Patrol 6 setting start	
	7	Call patrol 7	Patrol 7 setting start	
	8	Call patrol 8	Patrol 8 setting start	
	9	Patrol setting end		
	10	Patrol time setting(5-240sec.)		
	11	Patrol speed setting(1-63)		
Pattern Scan	1	Call pattern 1	Pattern 1 setting start	
	2	Call pattern 2	Pattern 2 setting start	
	3	Call pattern 3	Pattern 3 setting start	
	4	Call pattern 4	Pattern 4 setting start	
	5	Pattern setting end		

PTZ Control	1-8	Park preset 1-8		
	9-16	Park patrol 1-8		
	17-20	Park pattern 1-4		
	21	Park auto scan		
	22	Park AB lines scan		
	30	Park time 0(off)		
	31	Park time 10s		
	32	Park time 30s		
	33	Park time 60s		
	41	A line-scan setting		
	42	B line-scan setting		
	43	High speed line-scan start		
	44	Middle speed line-scan start		
	45	Low speed line-scan start		
	46	Inner arc line-scan		
	47	Outer arc line-scan		
	System Setting	50	Open autotracking	
51		Off autotracking		
52		Open zoom self-adaption		support IP speed dome camera with autotracking
53		Off zoom self-adaption		
Continuous call 10,12,14		Restore factory settings		
30		On/off Auto-flip		Support flip Dome Camera

Remark: Preset 35 could run Patrol 1, Default Preset Point No. 1~No.8

System Setting	01	TVI 1080P P		
	02	CVI 1080P P		
	03	AHD 1080P P		
	04	CVBS P		
	05	P		
	06	N		

### 3.5 Patrol Setting

Start patrol order “set preset 92+ call corresponding preset of patrol number”, then add preset “call preset”, every patrol path can add Max. 32 presets. After adding, save the setting by “set preset 92 + call preset 9”

The setting of preset standing time: “set preset 92 + call preset 10 + call corresponding preset of time”.

The setting of preset running speed in patrol: “set preset 92 + call preset 11 + call corresponding preset of speed;

[For example] add 1-4 presets in patrol 1, standing time 30s, speed 40, follow the instructions below:

Add preset in patrol path:

- (1) Set preset 92, call preset 1, start patrol 1 setting.
- (2) Call preset 1, add preset 1 to patrol 1.
- (3) Call preset 2, add preset 2 to patrol 1.
- (4) Call preset 3, add preset 3 to patrol 1.
- (5) Call preset 4, add preset 4 to patrol 1.
- (6) Call preset 92, then call preset 9, save patrol 1.

The setting of preset standing time in patrol:

- (1) Set preset 92, then call preset 10, start the setting of preset standing time.
- (2) Call preset 30, set standing time to 30s.

The setting of preset running speed in patrol:

- (1) Set preset 92, then call preset 11, start the setting of preset running speed.
- (2) Call preset 40, set preset running time to 40.

## 4.1 FAQs

Faults Phenomenon	Check part	Probable Cause	Solution
There is no action and no image after powered up	Check power adapter and power PCB	Power adapter	Change power supply
		Power circuit exist has problem	Replace
There is image, but do not self-test when powered on	Motor has abnormal sound	Mechanical problem	Overhaul if it get stuck in something
	PTZ Swings	Very incline	Set it straight
	N/A	Power is not enough	Change a new power supply that meet the requirements
	N/A	Something wrong with motherboard	replace
There is no image, but can do self-test after powered on	Connection line between power panel and connection panel	Do not insert properly	Insert again and push protective cover
	Video line, BNC Connector	Do not install contact properly	Make sure all connection is proper
There is image, and can do self-test, but can not control after powered on	RS485 communicate line	Something wrong with the circuit	Make sure all connection is proper
	N/A	Irregular operation leads to out of control	Power off and restart
		Something is wrong with the motherboard	replace
N/A	Speed dome camera is in state of manual focusing	Operate speed dome camera or call any one preset to make it back to auto. focusing	
Video image is Foggy	Transparent cover	Transparent cover is dirty	Clean transparent cover

## 4.2 Clean the Transparent Cover

In order to make the image clear, the cover need to be cleared timely. When clear, please be careful for avoiding to touch the transparent cover directly, the acid sweat of the human finger may rust the surface of the cover. The scratch of the flint to the transparent cover will lead to foggy image, affect the image quality. Please use soft enough dry cloth or other replacement to wipe the inner and surface. If seriously dirty, can use neutral cleanser, any high grade furniture cleanser can used to clean the transparent cover.

### 4.3 Lightning and Surge protection

Outdoor speed dome camera must consider thunder-proof and surge immunity. On the premise of guaranteeing electrical safety, we can take following lightning protection measures:

- At least keep 50m distance between signal transmission line and high voltage equipment or high voltage cable;
- Outdoor wiring under the eaves;
- For open field, adopt seal steel pipe buried wiring way, and adopt one-point earthing with the steel pipe. Do not adopt aerial wiring.
- It need to add extra high-frequency thunder-proof device and lightning rod in strong thunderstorms area or high inductive voltage region(such as high voltage substation);
- Thunder-proof and grounding design of Exterior installation and circuit must be in accordance with building lightningproof requirements; It must meet national standard and industry standard;
- System must be equipotential grounding. Grounding device must meet anti-jamming and electric safety dual requirements. The connection with strong electrified wire netting can't be short connection or mixed connection. When system is in the condition of single-phase grounding, ground impedance is less than  $4\Omega$ , ground wire cross-section area must be more than  $25\text{ mm}^2$ .

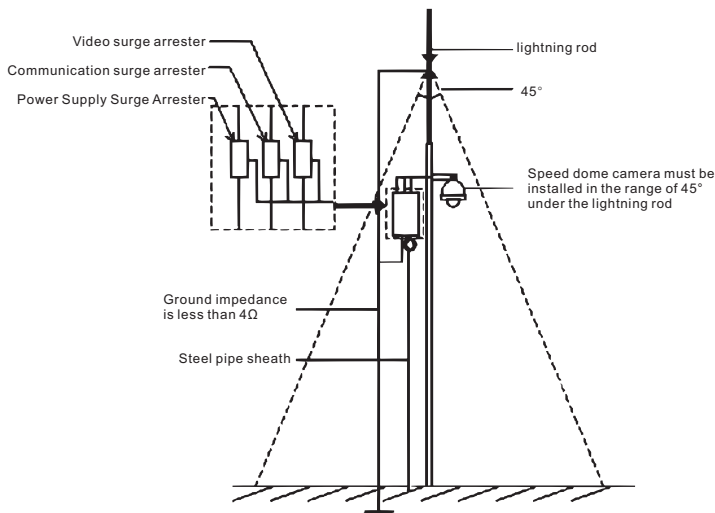

## 4.4 RS485 Bus Wiring

## 1. RS485 bus basic characteristic

RS485 industry bus is characteristic impedance  $120\Omega$  half-duplex communication bus according to RS485 industry bus standard.

## 2. RS485 bus transmission distance

When use 0.511mm (24AWG) screen twisted pair cable as communication cable. Depending on different baud rate, the longest transmitting distance theoretical value is shown as below:

The longest transmitting distance of baud rate

2400Bps 1800m

4800Bps 1200m

9600Bps 800m

## 3. Connection mode and terminal resistance

RS485 industry bus standard require adopt snake-like wiring(chrysanthemum chain), The ends must connect with  $120\Omega$  terminal resistance(such as figure 6), ease connection can adopt figure 7, but distance of section "D" can't exceed 7m.

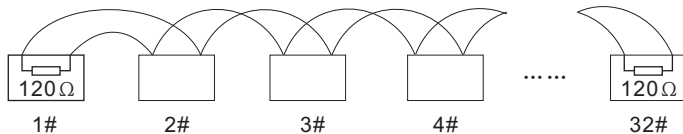

Fig6

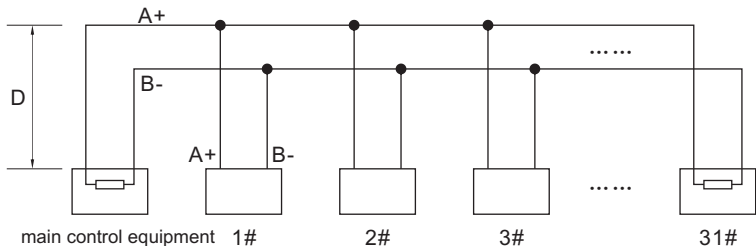

Fig7



